

# SPEARHEAD

TWIGA FLEX



## Vegetation Control – it’s in our makeup!

At Spearhead we are passionate about vegetation control machinery, it is a part of our makeup and it is what we have done best for more than 25 years.

## Twiga Reach Arm Mowers.

Since the launch of the Twiga series back in 1995, Spearhead has pioneered the development of reach mowers to create a vast product range to suit varying different budget types and applications. From machines designed to fit compact tractors through to the longest reach machines for watercourse management; there is a model for every landscape.

Twiga reach arms extend from a minimum of 3.2m to a maximum 8.9m, with a variety of arm types and machine control options to suit every operator’s requirements.

Spearhead’s diverse range of reach arm attachments complement the Twiga range, with flail heads between 1.0 and 1.6m for all hedge cutting and verge mowing purposes along with a variety of rotary heads and sawblades to suit every working requirement.

Be it an agricultural or municipal application, Spearhead sets the standard in reach mowing and hedge cutting machinery solutions.



Overview .....	4
Features .....	6
Dimensions .....	7
Arm Types .....	8
Mounting .....	9
Control Systems .....	10
Machine Features .....	11
Optional Equipment .....	12
<b>ATTACHMENTS</b>	
Flail Heads .....	14
Cutterbars .....	17
Sawblades .....	18
Rotary Heads .....	20
Ditch Cleaner .....	21
Specifications .....	22

VIEW OUR OTHER TWIGA RANGES

**TWIGA COMPACT**

**TWIGA CLASSIC**

**TWIGA MID**

**TWIGA PRO**

**TWIGA ORBITAL**

Designed specifically for professional operators requiring the most power, performance and productivity, Spearhead's flagship Twiga Flex provides the most versatile and high output machine on the market

Versatility is brought through a range of reaches between 5.8m and 8.9m and a variable and rearward reach geometry given through a 70 centimetre offset slew pivot. In addition, the Flex has the ability to be front or rear mounted and even reverse driven thanks to Spearhead's unique 'Rotorflex' head rotation system.

The Twiga Flex is controlled via Spearhead's flagship Propilot Electric Proportional Control System to provide the ultimate combination of user comfort and visibility.



AGRICULTURE



AMENITY









AIRFIELD



HIGHWAYS



	 TRACTOR POWER REQUIRED	 TRACTOR WEIGHT	 MACHINE POWER	 MACHINE WEIGHT	 MAXIMUM REACH	 TRANSPORT WIDTH
<b>TWIGA MID FLEX S59</b>	80hp	4000kg	85hp	2080kg	6.2m / 20' 4"	2.3m / 7' 7"
<b>TWIGA MID FLEX S63</b>	80hp	4250kg	85hp	2100kg	6.6m / 21' 8"	2.3m / 7' 7"
<b>TWIGA MID FLEX T69</b>	80hp	4500kg	85hp	2200kg	7.2m / 23' 7"	2.3m / 7' 7"
<b>TWIGA MID FLEX T74</b>	80hp	5000kg	85hp	2280kg	7.7m / 25' 3"	2.3m / 7' 7"
<b>TWIGA PRO FLEX S67</b>	120hp	5000kg	85hp	2200kg	6.5m / 21' 4"	2.3m / 7' 7"
<b>TWIGA PRO FLEX S74</b>	120hp	5250kg	85hp	2300kg	7.2m / 23' 7"	2.3m / 7' 7"
<b>TWIGA PRO FLEX T80</b>	120hp	5500kg	85hp	2800kg	7.8m / 25' 7"	2.3m / 7' 7"
<b>TWIGA PRO FLEX T89</b>	120hp	6000kg	85hp	2900kg	8.7m / 28' 6"	2.3m / 7' 7"

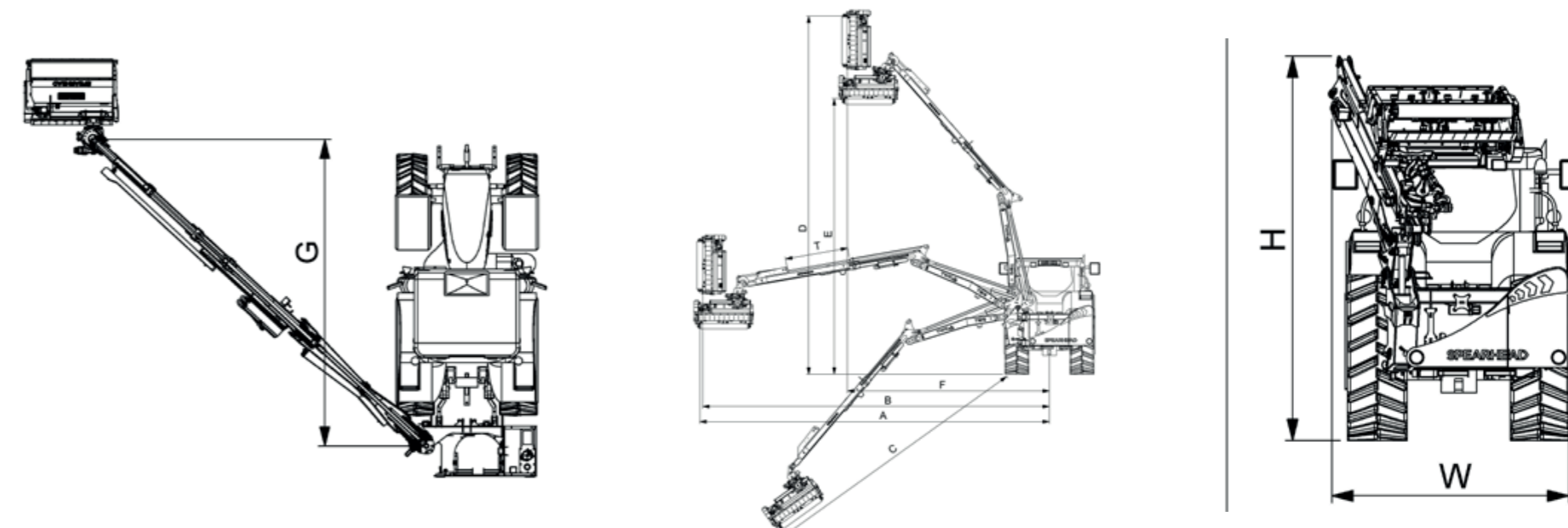
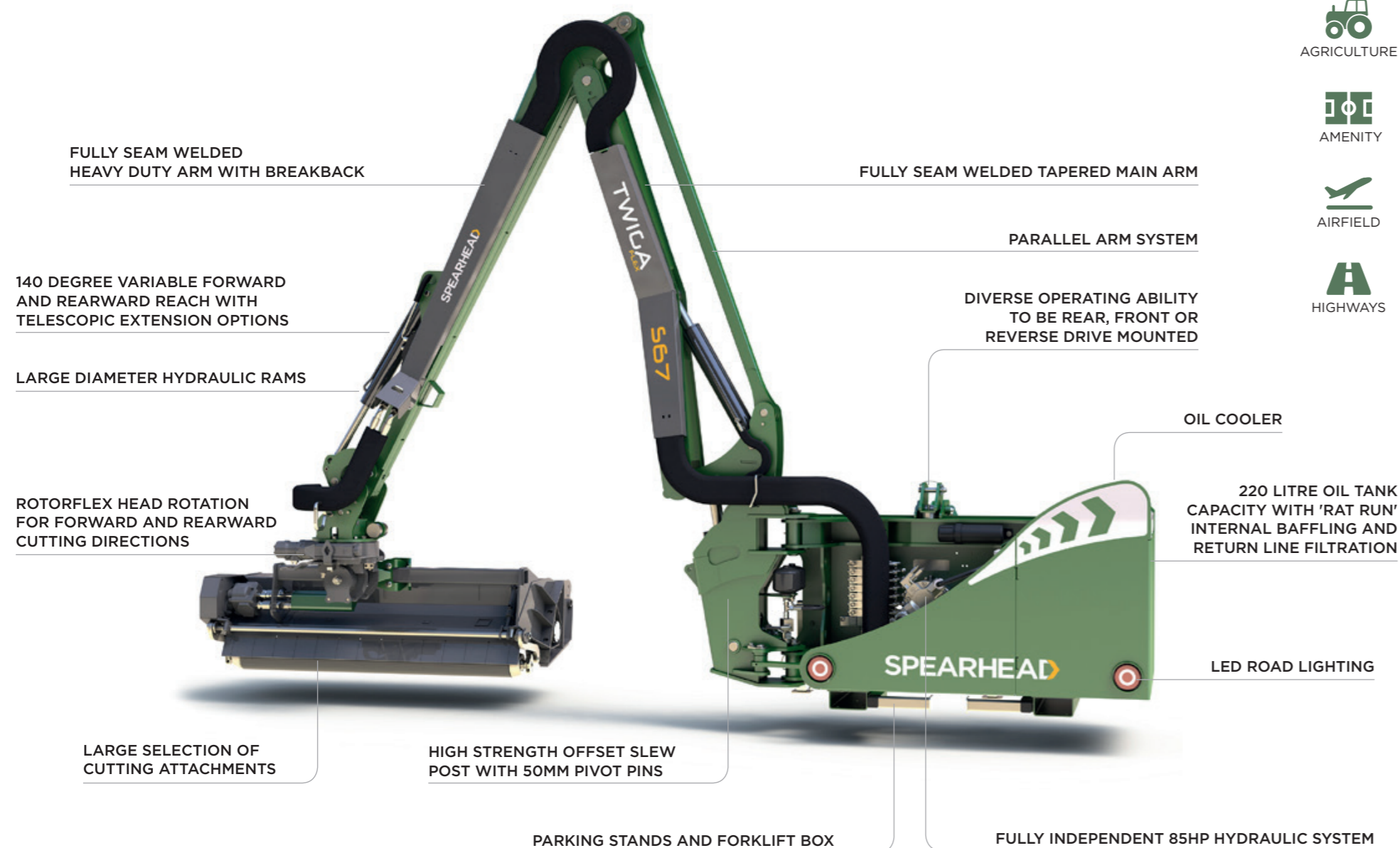

	A	B	C	D	E	F	G	W	H	T
<b>TWIGA MID FLEX S59</b>	6.2m / 20' 4"	6.1m / 20'	4.2m / 13' 9"	6.7m / 22'	4.6m / 15' 1"	3.8m / 12' 6"	3.1m / 10' 2"	2.3m / 7' 7"	3.8m / 12' 6"	—
<b>TWIGA MID FLEX S63</b>	6.6m / 21' 8"	6.5m / 21' 4"	4.5m / 14' 9"	7.0m / 23'	4.9m / 16' 1"	4.0m / 13' 1"	3.4m / 11' 2"	2.3m / 7' 7"	3.8m / 12' 6"	—
<b>TWIGA MID FLEX T69</b>	7.2m / 23' 7"	7.1m / 23' 4"	4.9m / 16' 1"	7.1m / 23' 4"	5.3m / 17' 5"	4.5m / 14' 9"	3.8m / 12' 6"	2.3m / 7' 7"	3.8m / 12' 6"	0.9m / 2' 11"
<b>TWIGA MID FLEX T74</b>	7.7m / 25' 3"	7.6m / 24' 11"	5.9m / 19' 4"	7.7m / 25' 3"	6.0m / 19' 8"	4.6m / 15' 1"	4.2m / 13' 9"	2.3m / 7' 7"	3.8m / 12' 6"	0.9m / 2' 11"
<b>TWIGA PRO FLEX S67</b>	6.5m / 21' 4"	6.4m / 21'	4.4m / 14' 4"	7.0m / 23'	5.0m / 16' 5"	3.9m / 12' 10"	3.2m / 10' 6"	2.3m / 7' 7"	3.5m / 11' 6"	—
<b>TWIGA PRO FLEX S74</b>	7.2m / 21' 4"	7.1m / 21'	5.2m / 14' 4"	7.7m / 25'	5.7m / 16' 5"	4.1m / 12' 10"	3.9m / 10' 6"	2.3m / 7' 7"	3.5m / 11' 6"	—
<b>TWIGA PRO FLEX T80</b>	7.8m / 25' 7"	7.7m / 25' 3"	5.7m / 18' 8"	8.0m / 26' 3"	6.0m / 19' 8"	4.8m / 15' 9"	4.2m / 13' 9"	2.3m / 7' 7"	3.5m / 11' 6"	1.2m / 3' 11"
<b>TWIGA PRO FLEX T89</b>	8.7m / 28' 7"	8.6m / 28' 3"	6.7m / 22"	8.9m / 29' 2"	6.9m / 22' 8"	5.0m / 15' 5"	4.8m / 15' 9"	2.3m / 7' 7"	3.8m / 2' 6"	1.5m / 4' 11"

## TWIGA FLEX ARM TYPES

Spearhead's leading Twiga Flex offering puts the focus on operator control and visibility, maximising productivity with a variety of arm types and build configurations to fit all operator requirements.

### ARM TYPES



#### S STANDARD

- › Industry standard
- › Robust performance
- › Fully tapered design
- › Superior geometry

#### T TELESCOPIC

- › Compact design
- › Improved flexibility
- › Additional reach where required
- › Easy arm extension



### BUILD CONFIGURATIONS



#### FRONT MOUNT

- › Increased forward reach ability and user comfort bringing the attachment always in clear view of the operator
- › Various build configurations



#### REAR MOUNT

- › Standard rear mount fitment with various mounting options



#### REVERSE DRIVE

- › Combine the 'Autoflex' feature of the Twiga Flex with the reverse drive of the tractor to increase operator comfort



#### BASIC

- › Utilises the hydraulic oil supply of the carrying prime mover

## TWIGA FLEX MOUNTING TYPES

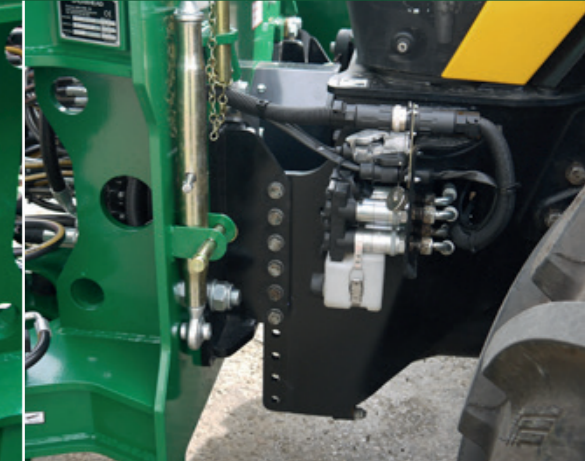

The Twiga Flex series is available with four alternative mounting options for stable and safe performance. Heavy duty and high strength in design, your Twiga can be easily mounted in minutes.



#### THREE POINT LINKAGE

- › Easy to fit
- › Heavy duty integrated stabiliser
- › Adjustable height settings
- › Pivoting top link nose
- › Cushioned main frame
- › Various nose ranges



#### FOUR POINT LINKAGE

- › Upgrade from standard three-point linkage
- › Additional support from tractor clevis hitch
- › Improves rigidity and stability



#### INTEGRATED AXLE MOUNT

- › Secures Twiga to tractor axle for superior rigidity and stability
- › Reduces wear on tractor and Twiga
- › Easy 'clip in' attachment

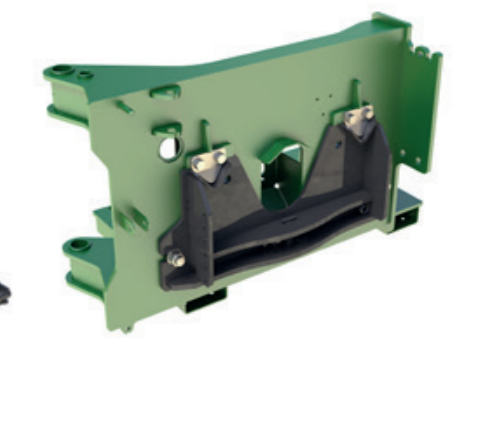

#### DIN/LOADER MOUNT

- › Rigid mount to DIN plate
- › Secures Twiga to tractor or other prime mover
- › Special build options available

\*Photographs for illustration purposes only.

Spearhead's flagship, state-of-the-art Propilot Electric Proportional control system comes standard on all Twiga Flex models. Benefitting from additional functionality on the joystick, Propilot offers the ultimate in all day comfort and control to the professional operator in an easy to use package.



### PROPILOT ELECTRIC PROPORTIONAL CONTROLS

- Precision control
- Compact design
- Professional comfort armrest
- Electric rotor control
- Secondary telescopic and head angle buttons for additional 'Flex' functions



### HEAD FLOAT

- Greater attachment ability in following changing ground contours across its width
- Automatically allows the head crowd to change its angling position during work



### PARALLEL ARM SYSTEM

- Allows movement in and out from the tractor without altering the height of the attachment
- Single movement of the joystick required

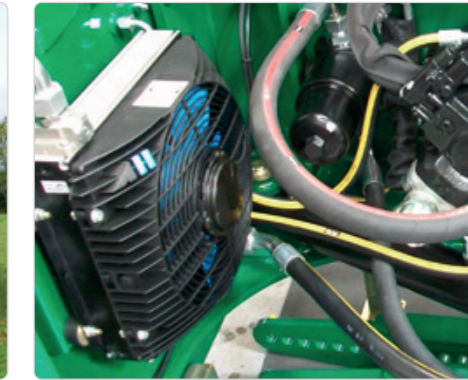

### OIL COOLER

- For machines working in demanding environments
- Electric temperature sensor
- Fitted in line and cools oil prior to returning into tank



### 148° HYDRAULIC SLEW

- Allows for variable movement in the arm during operation
- Allows for compact transportation



### CAB GUARD KIT

- Protects tractor and operator from flying debris
- Standard supply on all machines with universal fitment
- Contains all fasteners and mesh kit

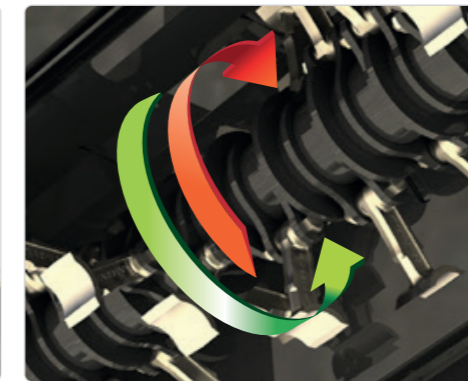

### DUAL DIRECTION ROTOR

- Fully independent hydraulics allows for downhill and uphill cutting
- Simple, rotor direction change through switch on controls
- Downhill cutting for heavy-duty mulching to break down heavy growth
- Uphill cutting for cleaner cut and finish

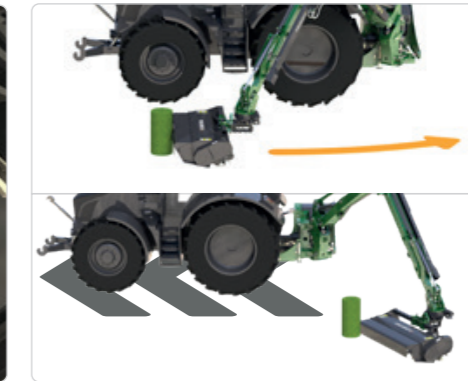

### BREAKBACK

- Automatically brings back and lifts the arm in the event of a collision with an object



### COUNTERWEIGHT

- 500kg additional weight in order to counteract the weight on the attachment and arm at maximum reach and ensure stability
- Recommended for telescopic reach arms and lighter frame tractors



**ARM FLOAT**

- Greater arm ability in following ground contours
- Automatically allows the arm to fall and raise during work



**MECHANICAL QUICK ATTACH\***

- Reduced time in changing multiple attachments
- No requirement for specific tools



**HYDRAULIC QUICK ATTACH**

- Quick release probe fittings replace standard adaptors
- Push and release by hand
- No requirement for specific tools



**DEBRIS BLOWER\***

- Blows cut debris back into the hedgerow
- Fitted to the rear of the oil tank
- Keeps roads and pathways clear



**AUTOPILOT\***

- Advanced automatic control system which allows the flail head to follow ground contours
- No requirement for any operator input
- Increased working speed and efficiency
- Reduced operator fatigue



**HIGHWAY KIT** Contains:

- Warning Arrow - magnetic pass sign placed on the rear of the oil tank to guide passing traffic
- Flashing LED's - additional lighting fitted to the rear panel of the machine increasing visibility
- Alternative Colour - for the requirements of the end user and/or increased visibility
- Highway Chevrons - for high visibility during night operations

\*Photographs for illustration purposes only.



**CLASS LEADING FORWARD REACH**

- 148° hydraulic slew
- Work in any position within the slewing arc
- Dual breakback system

**WORK FORWARD & BACK**

- Rotate head to work in reverse
- Flexibility to mount rear front or reverse drive

**DUAL ROTORFLEX**

- Easy head positioning
- 305° of head slew for ultimate head angling

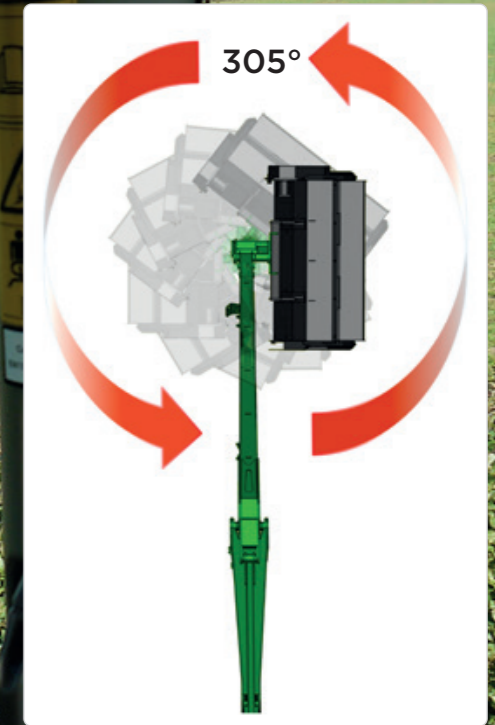



**AUTOFLEX**

- Allows automatic levelling of the cutting head
- Maintain a level finish without adjusting head angle position

**ALWAYS IN VIEW**

- Always looking at the work ahead
- No visibility loss compared to mid mount as you are always looking in front of the arm

**NARROW LANE WITH EASE**

- Work directly behind the wheel in narrow lanes
- Work behind the tractor wheel

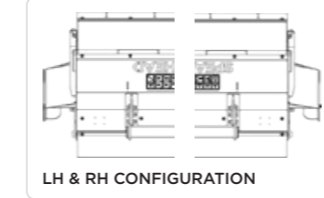
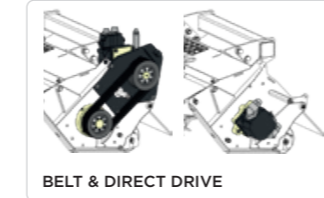
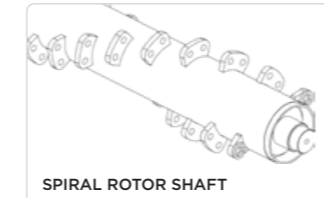

**VARIOUS FLAIL OPTIONS:**

1. C-Flail
2. Back-to-Back Flail
3. T-Flail
4. Heavy-duty T-Flail
5. Boot Flail

The MP1 head is favored by grass mowing professionals with its enclosed cowl, standard wear skirts and compact design. Featuring a host of flail options, this versatile head is also excellent for hedge cutting operations.



CUTTING WIDTH	NUMBER OF FLAILS	ROLLER CUTTING HEIGHT	APPLICATION	MINIMUM FLOW	PRESSURE
1.2m / 1.5m 4' / 5'	28 or 36	-20 - +160mm	GRASS/HEDGE	90 L/min	220 Bar
* Dependent on base unit specification					
		HYDRAULIC REAR ROLLER	COWL WEAR PLATE	REAR FLAP	HYDRAULIC FRONT HOOD*

**MPI FLAIL HEAD**

**UNIT OPTIONS**



# ATTACHMENTS MP2 FLAIL HEAD

Direct drive, reinforced side walls, an open throat and compact hood, make this head ideal for heavy duty hedge cutting operations.

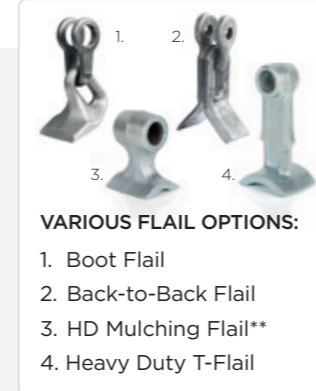
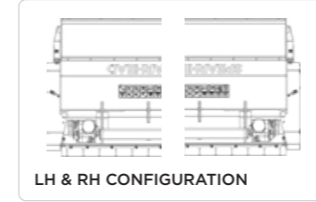
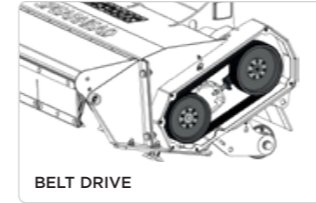
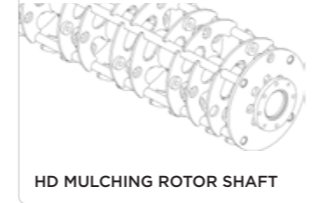
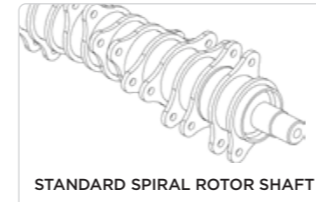
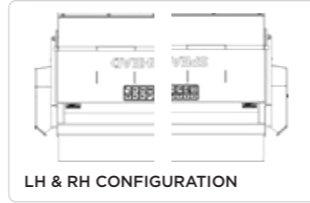
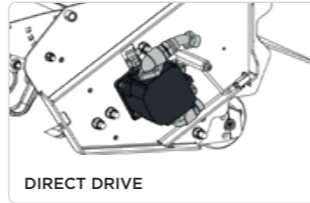
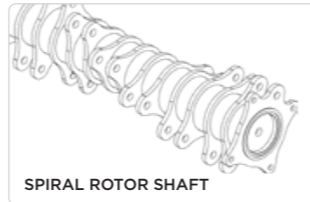
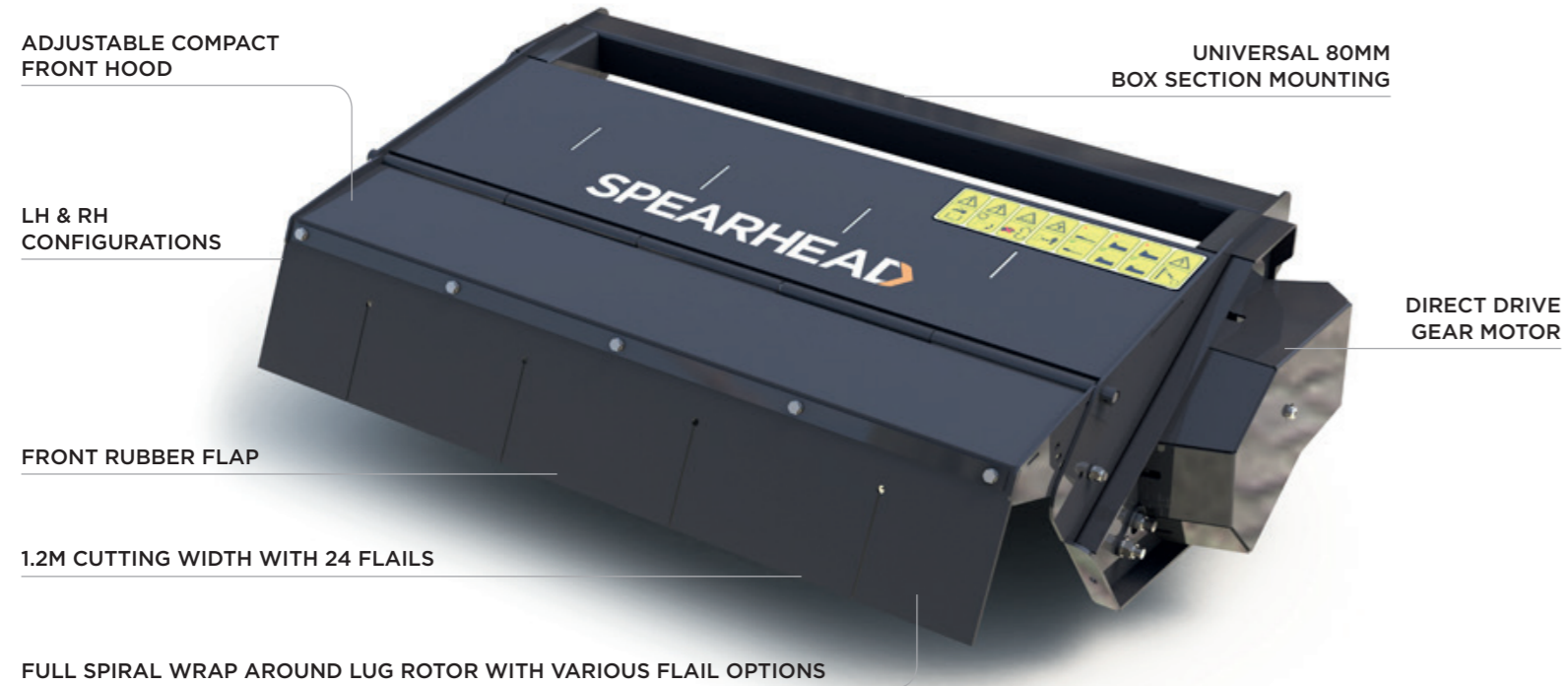

# ATTACHMENTS PROJECT BLACK FLAIL HEAD

Belt drive with a maximum 1.6m cutting width, this all-round head is perfect for high output in all applications. Specify with a HD mulching rotor for extreme applications.

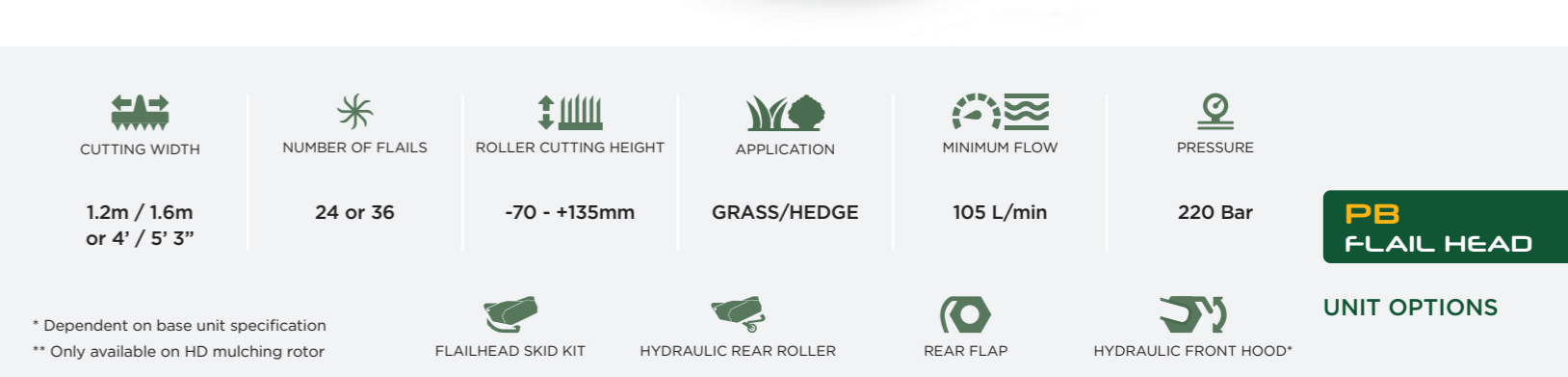
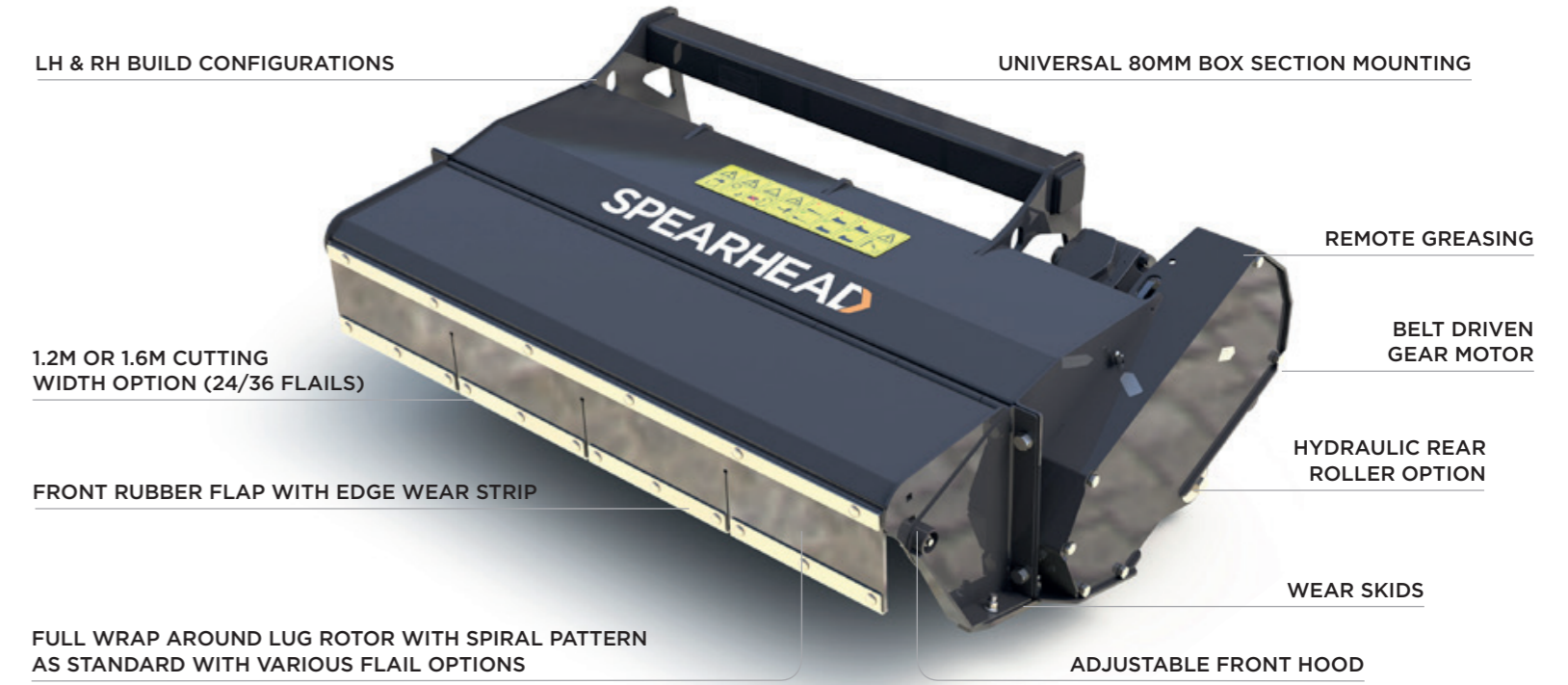

<b>MP2 FLAIL HEAD</b>	CUTTING WIDTH	NUMBER OF FLAILS	CUTTING HEIGHT	APPLICATION	MINIMUM FLOW	PRESSURE
	1.2m / 4'	24	-80 - +125mm	GRASS/HEDGE	90 L/min	220 Bar
<b>UNIT OPTIONS</b>	REAR FLAP	FLAILHEAD SKID KIT				

<b>PB FLAIL HEAD</b>	CUTTING WIDTH	NUMBER OF FLAILS	ROLLER CUTTING HEIGHT	APPLICATION	MINIMUM FLOW	PRESSURE
	1.2m / 1.6m or 4' / 5' 3"	24 or 36	-70 - +135mm	GRASS/HEDGE	105 L/min	220 Bar
<b>UNIT OPTIONS</b>	FLAILHEAD SKID KIT	HYDRAULIC REAR ROLLER	REAR FLAP	HYDRAULIC FRONT HOOD*		

\* Dependent on base unit specification  
\*\* Only available on HD mulching rotor

# ATTACHMENTS CUTTERBARS

Spearhead's range of lightweight standard duty and heavy duty cutterbars are perfect for regular routine hedge cutting maintenance operations.

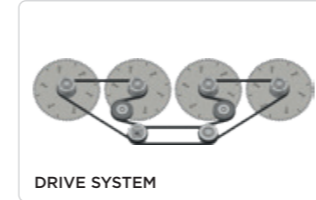
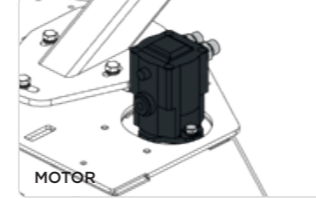
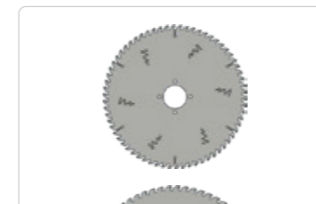
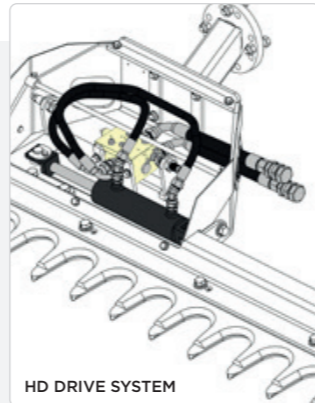
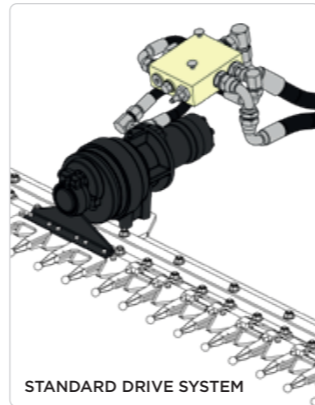
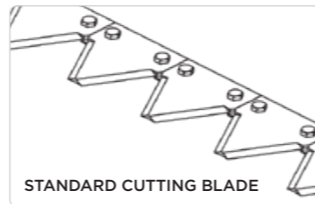
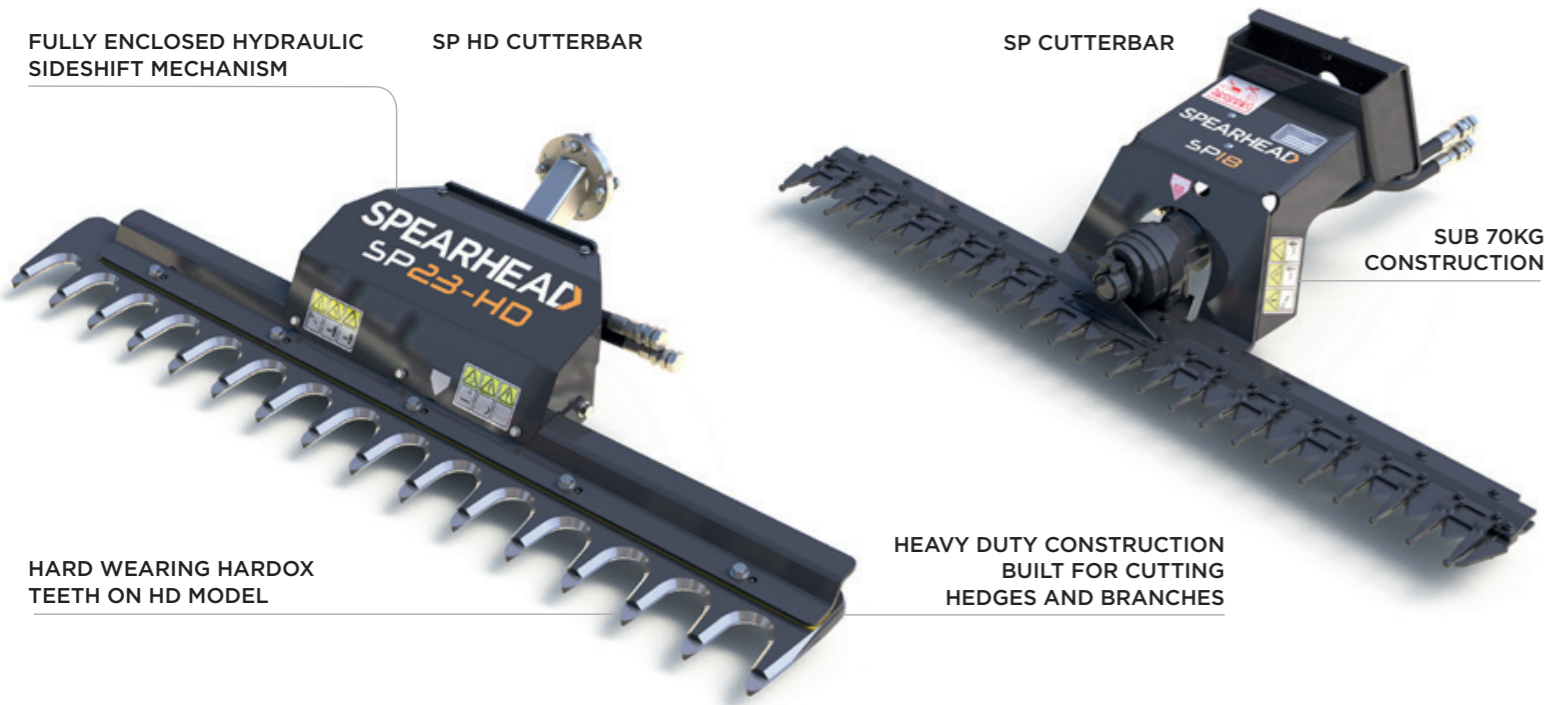

# ATTACHMENTS SAWBLADES

Spearhead's Trisaw and Quadsaw sawblades are designed for the felling of larger diameter branches and overgrowth which cannot be cut using the regular flail head, rotary head or cutterbar. Sawblades provide an excellent finish on material up to 200mm in diameter.

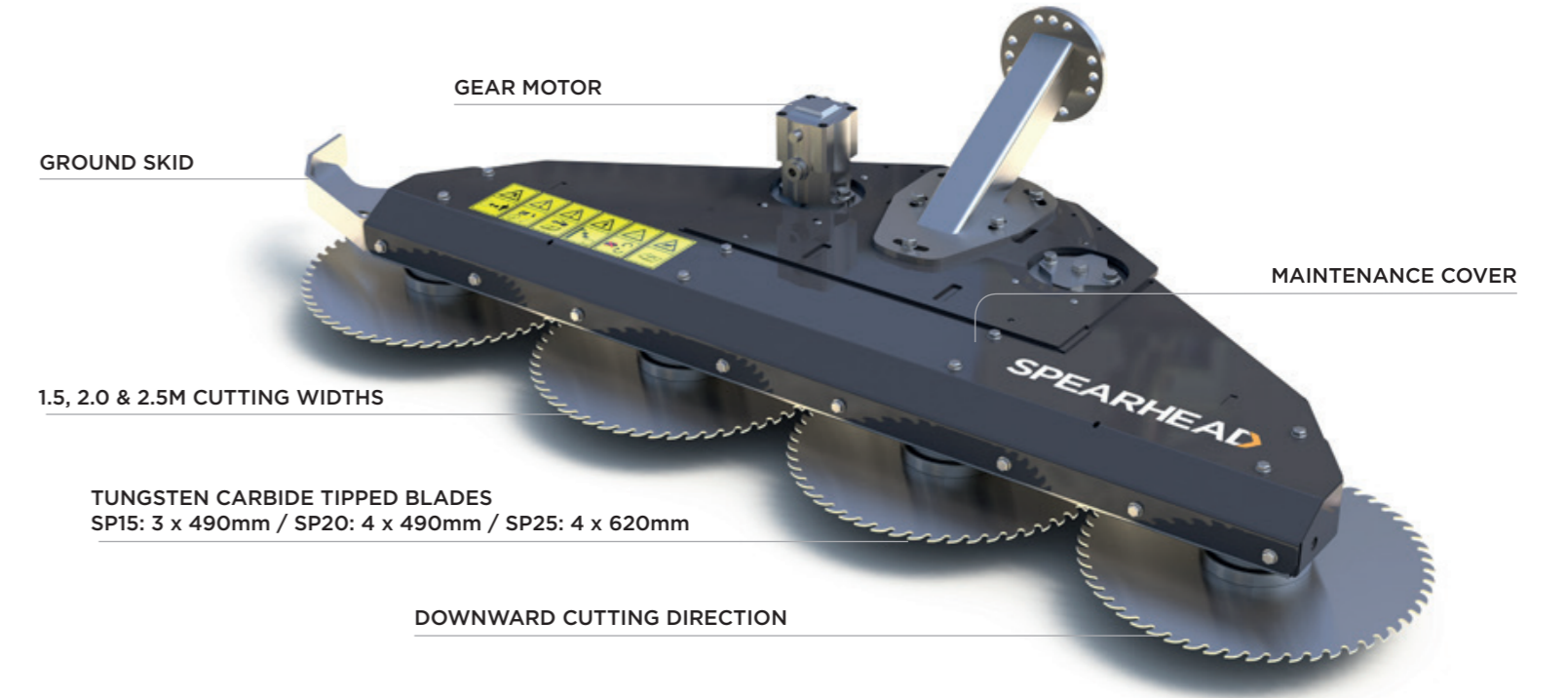

TUNGSTEN CARBIDE TIPPED BLADES  
 SP15: 3 x 490mm / SP20: 4 x 490mm / SP25: 4 x 620mm

	CUTTING WIDTH	NO. OF BLADES	CUTTING CAPACITY	APPLICATION	MINIMUM FLOW	PRESSURE
<b>SP15 CUTTERBAR</b>	1.5m / 4' 9"	19	40mm	HEDGE	50 l/min	180 bar
<b>SP18 CUTTERBAR</b>	1.8m / 5' 9"	23	40mm	HEDGE	50 l/min	180 bar
<b>SP21 CUTTERBAR</b>	2.1m / 6' 9"	27	40mm	HEDGE	50 l/min	180 bar
<b>SP17 HD CUTTERBAR</b>	1.7m / 5' 6"	26	100mm	HEDGE	50 l/min	220 Bar
<b>SP23 HD CUTTERBAR</b>	2.3m / 7' 5"	30	100mm	HEDGE	50 l/min	220 Bar
<b>SP27 HD CUTTERBAR</b>	2.7m / 8' 8"	36	100mm	HEDGE	50 l/min	220 Bar

CUTTING WIDTH	NUMBER OF BLADES	CUTTING CAPACITY	APPLICATION	MINIMUM FLOW	PRESSURE
1.5m / 4'9"	3	150mm	HEDGE	84-87 L/min	180 bar
2.0m / 6' 5"	4	150mm	HEDGE	84-87 L/min	220 Bar
2.5m / 7' 9"	4	150mm	HEDGE	84-87 L/min	220 Bar

- SP15 TRISAW**
- SP20 QUADSAW**
- SP25 QUADSAW**

# ATTACHMENTS ROTARY HEADS

Spearhead's wide range of rotary heads offer an alternative to the conventional flail head and are utilized in roadside mowing applications where heavier undergrowth and rocks are present.

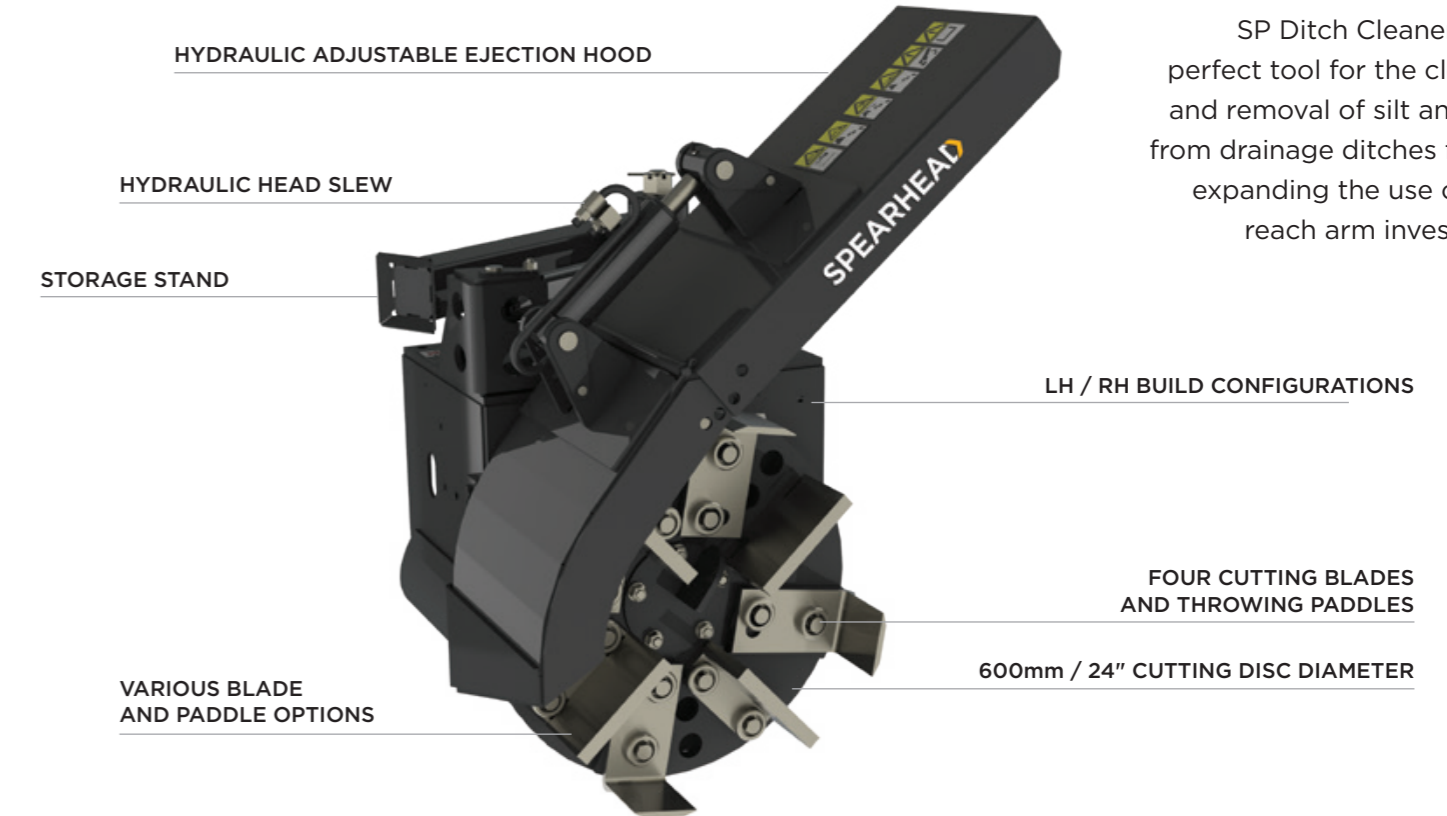
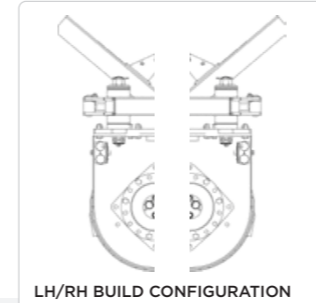
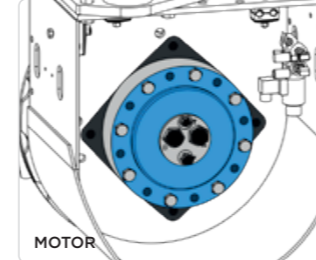
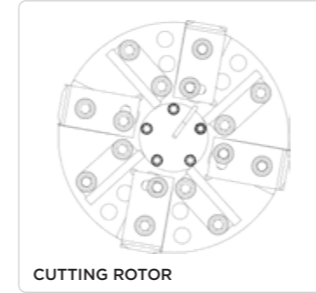
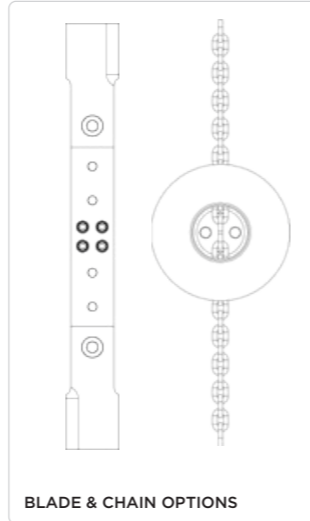
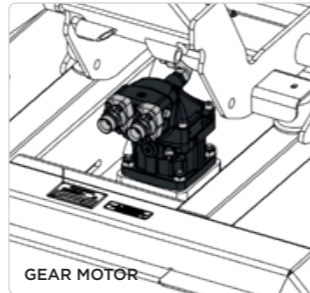
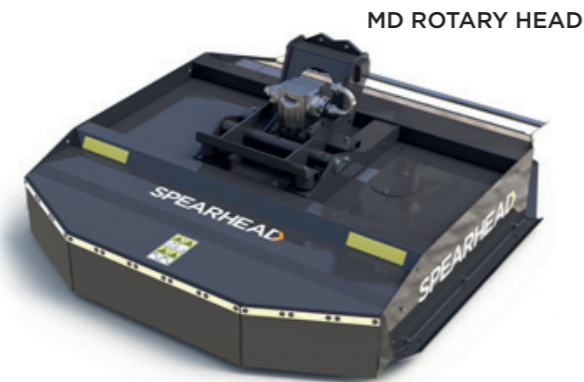
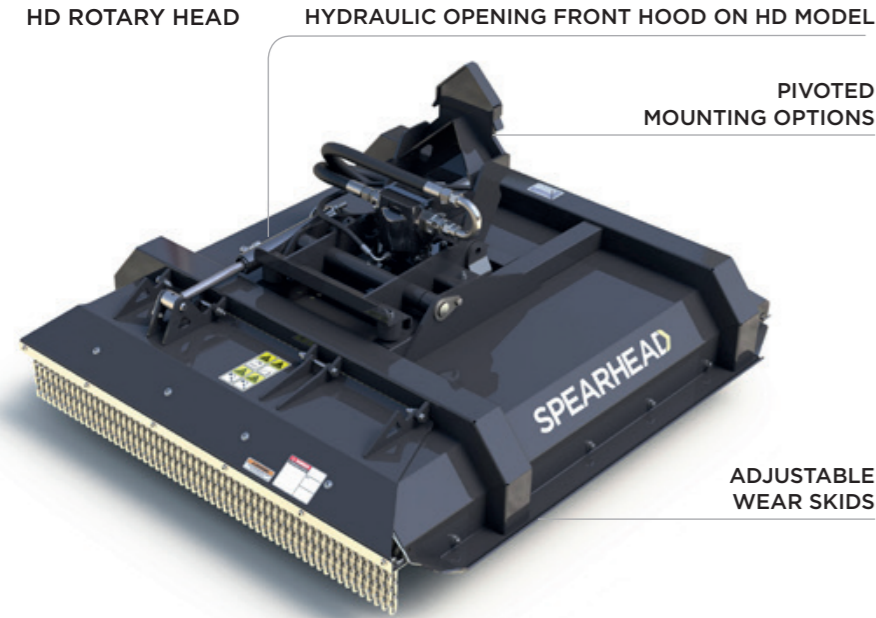

SP Ditch Cleaner is the perfect tool for the cleaning and removal of silt and mud from drainage ditches further expanding the use of your reach arm investment.

	CUTTING WIDTH	NUMBER OF BLADES/CHAINS	CUTTING CAPACITY	CUTTING HEIGHT	APPLICATION	MINIMUM FLOW	PRESSURE
<b>SPI2 MD ROTARY HEAD</b>	1.2m / 3' 11"	2 (blades or chains)	100mm	50-75mm	GRASS/HEDGE	90 L/min	300 Bar
<b>SPI5 MD ROTARY HEAD</b>	1.5m / 4' 11"	2 (blades or chains)	100mm	50-75mm	GRASS/HEDGE	90 L/min	300 Bar
<b>SPI2 HD ROTARY HEAD</b>	1.2m / 3' 11"	2 (blades) or 3 (chains)	150mm	13-65mm	GRASS/HEDGE	90 L/min	300 Bar
<b>SPI5 HD ROTARY HEAD</b>	1.5m / 4' 11"	2 (blades) or 3 (chains)	150mm	13-65mm	GRASS/HEDGE	90 L/min	300 Bar
<b>SPI2 SHD ROTARY HEAD</b>	1.2m / 3' 11"	2 (chains)	150mm	65mm	GRASS/HEDGE	90 L/min	300 Bar



CUTTING DIAMETER	NUMBER OF CUTTING BLADES	APPLICATION	MINIMUM FLOW	PRESSURE
600mm / 24"	4	DITCH/GRIP	90 L/min	220 Bar

**SP DITCH CLEANER**

TWIGA FLEX	MID S59	MID S63	MID T69	MID T74	PRO S67	PRO S74	PRO T80	PRO T89
<b>SPECIFICATION</b>								
Machine Weight*	2080kg	2100kg	2200 kg	2280kg	2200 kg	2300kg	2800kg	2900kg
<b>TRACTOR REQUIREMENTS</b>								
Minimum Tractor Weight	4000kg	4250kg	4500kg	5000kg	5000kg	4250kg	5500kg	6000kg
Tractor HP Guideline	80hp	80hp	80hp	80hp	120hp	120hp	120hp	120hp
<b>TWIGA CONTROL SYSTEMS</b>								
Progressive Cable Control System	□	□	□	□	—	—	□	—
Pro Pilot Electric Proportional Controls	■	■	■	■	■	■	■	■
<b>MOUNTING</b>								
Rear Three Point Linkage	■	■	■	■	■	■	■	■
Rear Three Point Linkage with Four Point Kit	□	□	□	□	□	□	□	□
Rear three point linkage with 5 Point Axle Mount	□	□	□	□	□	□	□	□
DIN/Loader Mount	□	□	□	□	□	□	□	□
<b>ARM TYPES</b>								
Standard Arm = S	■	■	—	—	■	■	—	—
Telescopic Arm = T	—	—	■	■	—	—	■	■
Parallel Arm System	■	■	■	■	■	■	■	■
Hydraulic Parallel System	□	□	□	□	□	□	□	□
<b>HYDRAULIC SYSTEM</b>								
System	Gear	Gear	Gear	Gear	Gear	Gear	Gear	Gear
Pump	Iron	Iron	Iron	Iron	Iron	Iron	Iron	Iron
Pump Arrangement	Twin	Twin	Twin	Twin	Twin	Twin	Twin	Twin
Drive Type	Fully Independent	Fully Independent	Fully Independent	Fully Independent	Fully Independent	Fully Independent	Fully Independent	Fully Independent
Tank Capacity	220 ltrs	220 ltrs	220 ltrs	220 ltrs	220 ltrs	220 ltrs	220 ltrs	220 ltrs
Horsepower	85hp	85hp	85hp	85hp	85hp	85hp	85hp	85hp
Flow Rate (L/Min)	105 l/min	105 l/min	105 l/min	105 l/min	105 l/min	105 l/min	105 l/min	105 l/min
<b>KEY FEATURES &amp; OPTIONS</b>								
Hydraulic Slew	■	■	■	■	■	■	■	■
Dual Direction Break Back	■	■	■	■	■	■	■	■
Dual Direction Rotor (Electric)	■	■	■	■	■	■	■	■
Head Float	■	■	■	■	■	■	■	■
Arm Float	□	□	□	□	□	□	□	□
Oil Cooler	■	■	■	■	■	■	■	■
Hydraulic Oil	■	■	■	■	■	■	■	■
Biodegradeable Oil	□	□	□	□	□	□	□	□
Narrow Lane Bracket	□	□	□	□	□	□	□	□
Mechanical Quick Release Kit (1 Set - M/F)	□	□	□	□	□	□	□	□
Hydraulic Quick Release Kit (1 Set - M/F)	□	□	□	□	□	□	□	□
Hydraulic Roller*	□	□	□	□	□	□	□	□
Autoflex	□	□	□	□	□	□	□	□
Autopilot	□	□	□	□	□	□	□	□
Additional hyd' service controlled from Twiga control system	□	□	□	□	□	□	□	□
Counterweight	□	□	□	□	□	□	□	□
1000rpm	□	□	□	□	□	□	□	□
<b>SAFETY EQUIPMENT</b>								
Cab Guard Kit	■	■	■	■	■	■	■	■
Debris Blower And Mounting Kit	□	□	□	□	□	□	□	□
Warning Arrow Kit	□	□	□	□	□	□	□	□
LED Road Lighting Kit	□	□	□	□	□	□	□	□
Boom light	□	□	□	□	□	□	□	□

\* Dependent on specification with oil less attachment

TWIGA FLEX	MID S59	MID S63	MID T69	MID T74	PRO S67	PRO S74	PRO T80	PRO T89
<b>MP COMPACT FLAILHEADS</b>								
1.0m MP Compact Direct Drive Flail Head	—	—	—	—	—	—	—	—
<b>MP1 FLAILHEADS</b>								
1.2m MP1 Direct Drive Flail Head	✓	✓	✓	✓	✓	✓	✓	✓
1.2m MP1 Belt Drive Flail Head	✓	✓	✓	✓	✓	✓	✓	✓
1.5m MP1 Direct Drive Flail Head	✓	✓	✓	✓	✓	✓	✓	✓
1.5m MP1 Belt Drive Flail Head	✓	✓	✓	✓	✓	✓	✓	✓
<b>MP2 FLAILHEADS</b>								
1.2m MP2 Direct Drive Flail Head	✓	✓	✓	✓	✓	✓	✓	✓
<b>PB FLAILHEADS</b>								
1.2m PB Belt Drive Flail Head	✓	✓	✓	✓	✓	✓	✓	✓
1.2m PB Belt Drive Flail Head - HD Mulching Rotor	✓	✓	✓	✓	✓	✓	✓	✓
1.6m PB Belt Drive Flail Head	✓	✓	✓	✓	—	—	✓	—
<b>SP CUTTERBARS</b>								
SP15 Cutterbar	✓	✓	✓	✓	✓	✓	✓	✓
SP18 Cutterbar	✓	✓	✓	✓	✓	✓	✓	✓
SP21 Cutterbar	✓	✓	✓	✓	✓	✓	✓	✓
<b>SP HD CUTTERBARS</b>								
SP17 HD Cutterbar	✓	✓	✓	✓	✓	✓	✓	✓
SP23 HD Cutterbar	✓	✓	✓	✓	✓	✓	✓	✓
SP27 HD Cutterbar	✓	✓	✓	✓	✓	✓	✓	✓
<b>SP QUADSAWS</b>								
SP15 Quadsaw	✓	✓	✓	✓	✓	✓	✓	✓
SP20 Quadsaw	✓	✓	✓	✓	✓	✓	✓	✓
SP25 Quadsaw	✓	✓	✓	✓	✓	✓	✓	✓
<b>SP ROTARY HEADS</b>								
SP12 MD Rotary Head	✓	✓	✓	✓	✓	✓	✓	✓
SP15 MD Rotary Head	✓	✓	✓	✓	✓	✓	✓	✓
SP12 HD Rotary Head	✓	✓	✓	✓	✓	✓	✓	✓
SP15 HD Rotary Head	✓	✓	✓	✓	✓	✓	✓	✓
SP12 Super HD Rotary Head	✓	✓	✓	✓	✓	✓	✓	✓
SP15 Super HD Rotary Head	✓	✓	✓	✓	✓	✓	✓	✓
<b>SP ROTARY DITCH CLEANERS</b>								
SP Ditch Cleaner	✓	✓	✓	✓	✓	✓	✓	✓

# SPEARHEAD

📍 Station Road, Salford Priors, Evesham, Worcestershire, WR11 8SW, England 📞 +44 (0)1789 491860

✉️ [enquiries@spearheadmachinery.com](mailto:enquiries@spearheadmachinery.com) 🌐 [spearheadmachinery.com](http://spearheadmachinery.com) 🐦 [SpearheadWorld](#)



designed and built in  
**GREAT BRITAIN** 

Spearhead  
is a member of the  
  
Alamo Group